

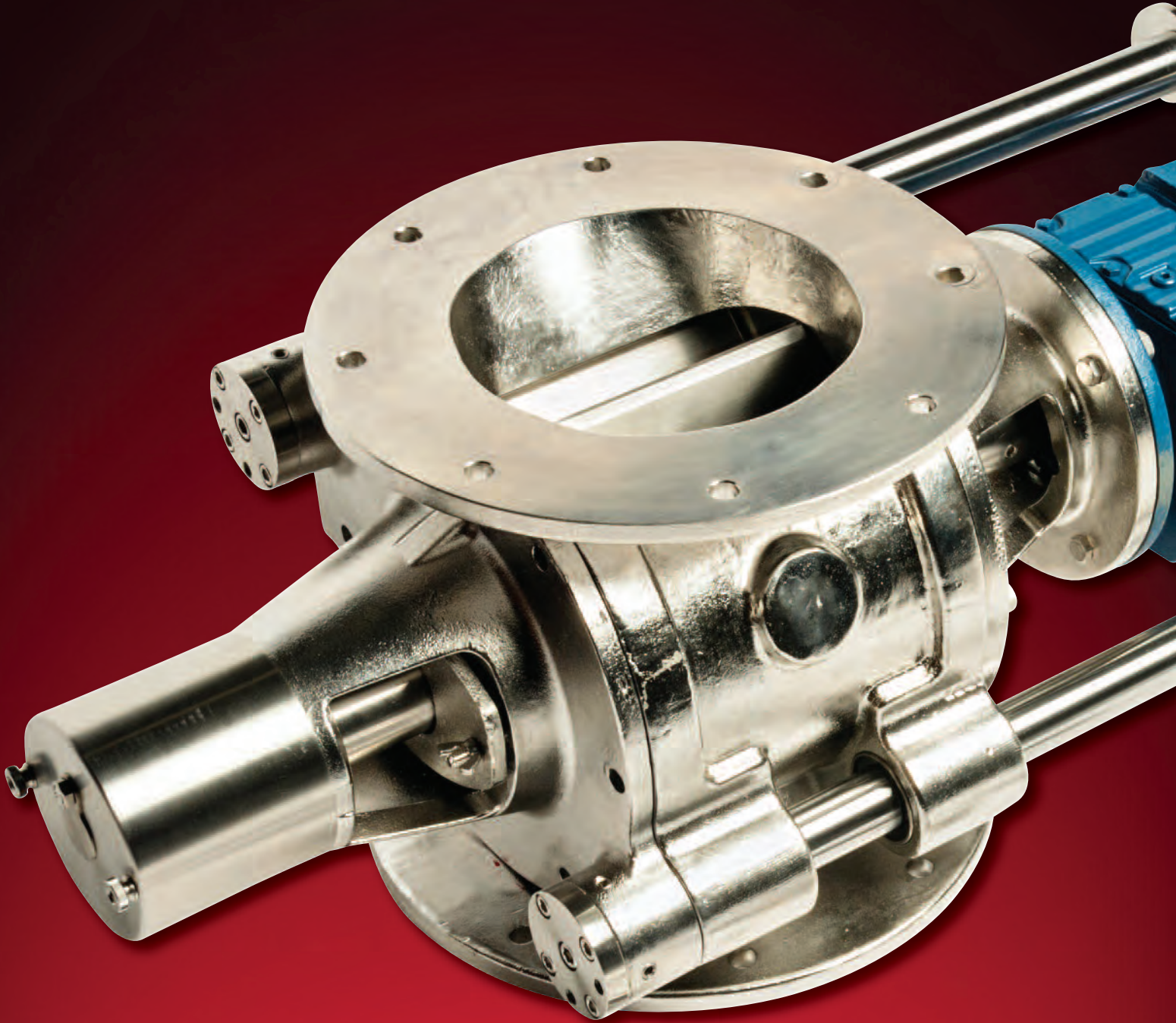

ROTARY AIRLOCK VALVES



ROTARY AIRLOCK VALVES

For over half a century, Meyer Rotary Airlock Valves have been leading the industry in design, workmanship, functionality, longevity and serviceability. They have repeatedly proven to be the best available. So it should come as no surprise that we ship more units than any other company in North America...three times as many in fact!

Our rotary airlock valves are used in a wide range of applications where there is need to minimize system air loss while transferring material between vessels with differing pressures. They are used as feeder valves to meter the flow of material between vessels with equivalent pressures. You will also find them doing double duty in systems where there is a need to minimize system air or gas loss while regulation the flow of material between vessels with differing pressures. You can count on Meyer to bring the right solution to your specific needs.

Asphalt	Grain	Powder Coating
Baking	Mining	Rubber
Cement	Paint	Textile
Chemical	Paper	Tobacco
Dairy	Pharmaceutical	Wood
Food	Plastic	Energy

UD SERIES **PAGE 4-7**

Universal Duty
Dust Duty

HD SERIES **PAGE 8-15**

Heavy-Duty Extra Tough
Heavy-Duty Abrasion Resistant
Heavy-Duty XP
Heavy-Duty Blow-Thru
Heavy-Duty Pellet Valve
Heavy-Duty Side Entry

SV SERIES **PAGE 16-19**

Kwik-Klean
Klean-In-Place II

CV SERIES **PAGE 20-25**

Fabricated Valves
High-Pressure
Custom Design

SYSTEM COMPONENTS **PAGE 26**

SERVICE AND PARTS **PAGE 27**

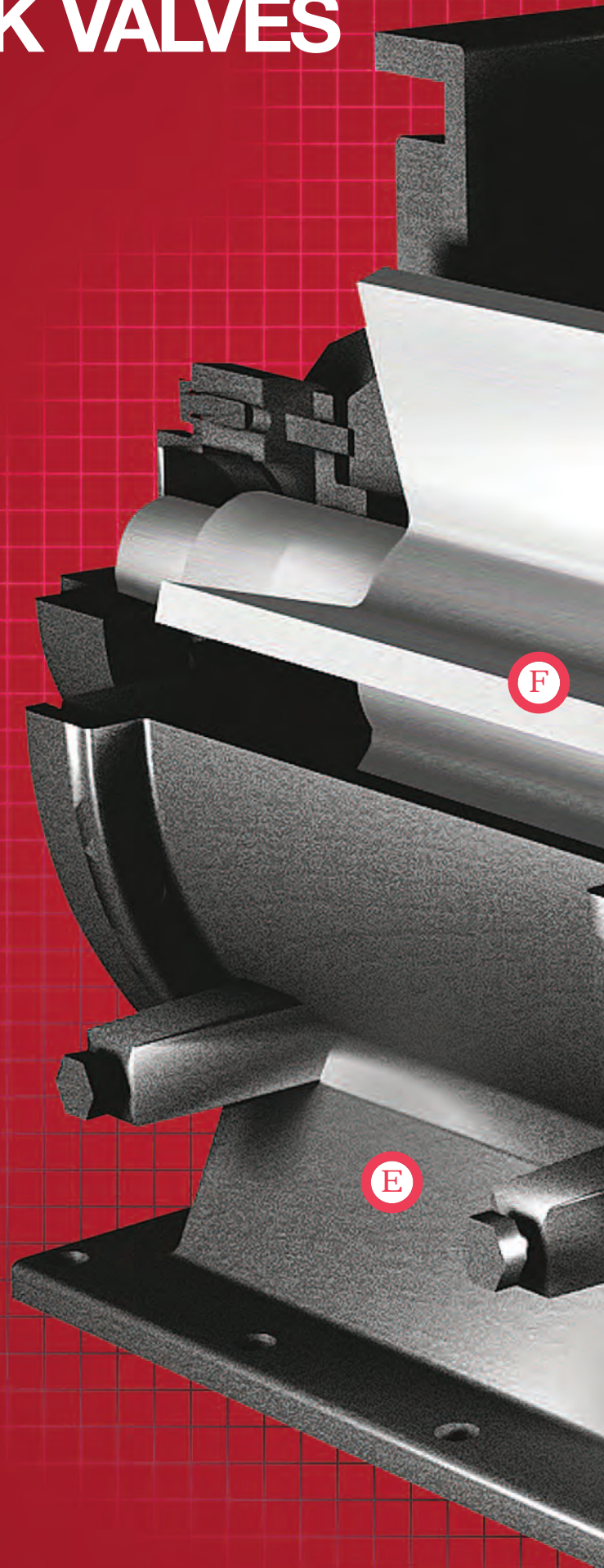

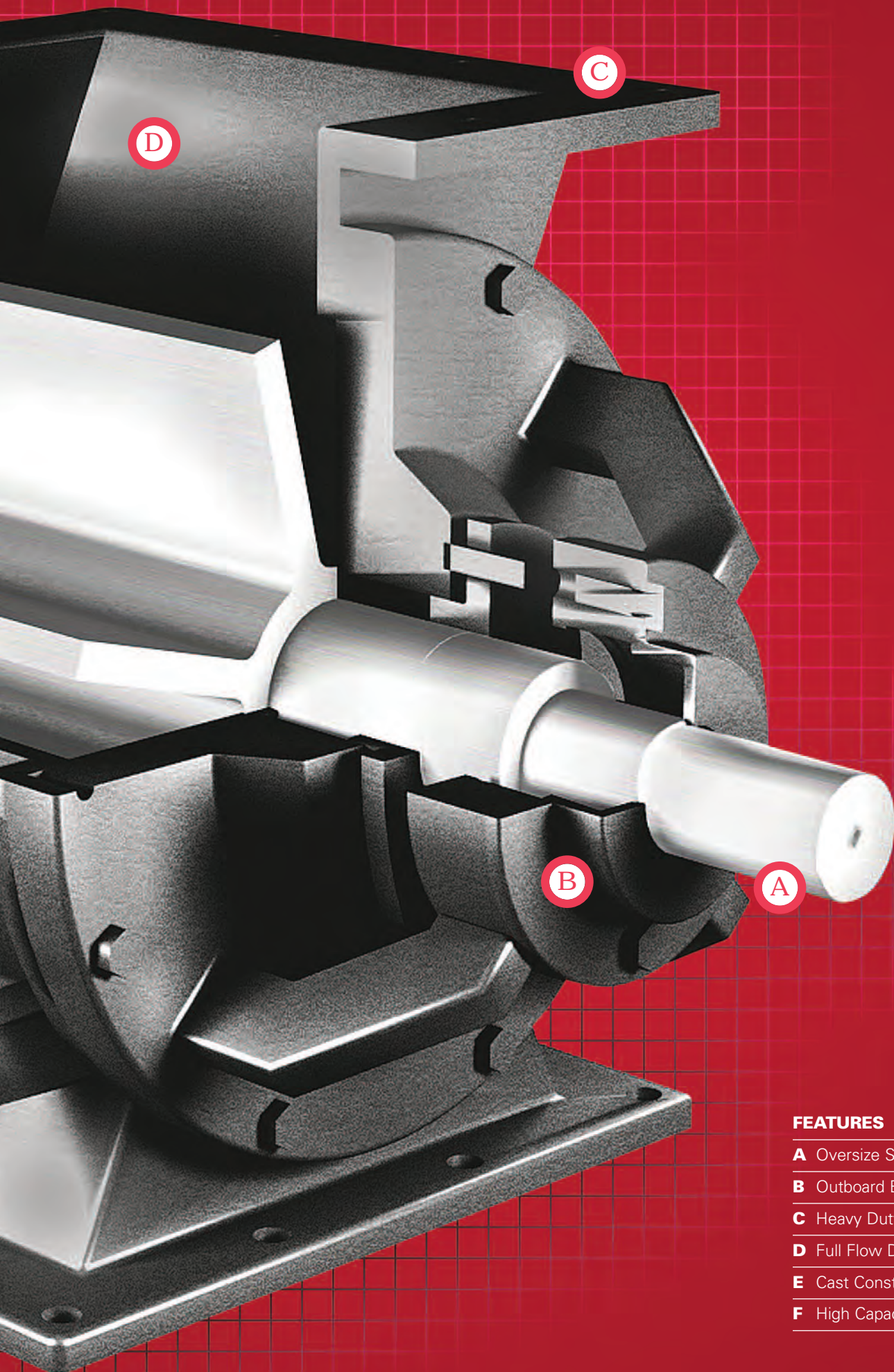

FEATURES

- A Oversize Shafts
- B Outboard Bearings
- C Heavy Duty Oversize Flanges
- D Full Flow Design
- E Cast Construction
- F High Capacity Rotors

The logo features the letters 'UD' in a large, bold, red sans-serif font. Below 'UD', the word 'SERIES' is written in a smaller, black, spaced-out sans-serif font. A thin vertical white line is positioned to the right of the logo.

UD SERIES

MEYER Universal Duty Series airlock valves provide the customer a great valve for low pressure conveying and dust collection applications. These units utilize one piece rotors with cast machined housings for a superior seal. All units utilize permanently lubricated outboard bearings insuring low maintenance.



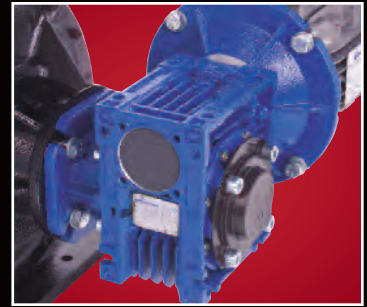
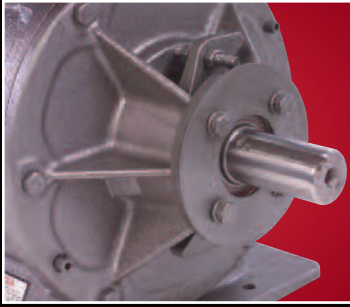

UDV

The UDV Universal Duty Drop-Thru Valves are designed for economical and reliable material metering and airlock service. The perfect solution for low pressure pneumatic conveying. Ideal for pollution control applications beneath dust collectors and cyclone separators.

DDV

The DDV Dust Duty Drop-Thru Valves are designed to provide a low cost airlock solution for simple light duty dust collection applications under baghouses and cyclones.



SQUARE	CFR	ROUND	CFR
6	0.095	6	0.095
8	0.23	8	0.23
10	0.48	10	0.48
12	0.90	12	0.90
14	1.54	14	1.54

The UDV Universal Duty Valves are designed for economical and reliable material metering and airlock service.

Ideal for pollution control applications in wood, grain, food, textile, paper, tobacco, rubber, and paint industries, the UDV valve works beneath dust collectors and cyclone separators where temperatures do not exceed 350°F and pressure differentials are less than 7 PSI.

The UDV valves are available with square or round flanges; they feature rugged castings and larger shaft diameters than the competition.

UNMATCHED COMPETITIVE ADVANTAGES:

- Available in five sizes from 6 through 14
- Round or square flange assures system compatibility
- 8 vane open end rotor
- Full flow throat design permits maximum flow to rotor pocket
- Oversize shaft diameters reduce deflection for maximum torque
- Rugged cast iron construction and stainless steel provides maximum structural stability
- Outboard sealed bearings never need lubrication
- Application specific options including speed switches, motors, drives and accessories
- Externally replaceable packing with split compression design

COMMON SERVICE CONDITIONS:

- Pressure Rating: 7 PSI
- Maximum Operating Temperature: 350°F
- Materials: Dry Free Flowing Mildly Abrasive

TYPICAL APPLICATIONS:

Dust Collection	Metering
Cyclone Separator	Low Pressure Conveying Systems

RELEVANT INDUSTRIES:

Wood	Grain
Food	Textile
Paper	Tobacco
Rubber	Paint

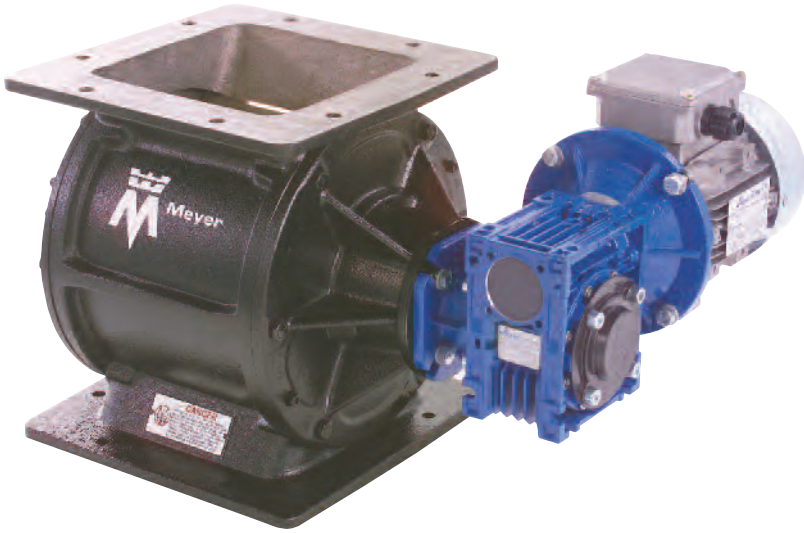

SQUARE	CFR	ROUND	CFR
6	0.095	6	0.095
8	0.23	8	0.23
10	0.48	10	0.48
12	0.90	12	0.90
14	1.54	14	1.54

The DDV Dust Duty Valves are designed to provide a low cost airlock solution for simple dust collection under baghouses and cyclones.

This design is uniquely suited for a low pressure application where a quality air seal is necessary in light duty non-abrasive dust collection applications.

The DDV valves are available in sizes 6 through 14 with square or round housings to match most collector discharge flanges.

UNMATCHED COMPETITIVE ADVANTAGES:

- Available in five sizes from 6 through 14
- Maintenance-Free direct drive at 22 RPM
- 8-Vane open end rotor - beveled edges
- Replaceable urethane sealstrips (optional)
- Cast iron or stainless steel machined housings and endplates
- C-Face standard motor
- Round or square flange assures system capabilities
- Outboard sealed bearings never need lubrication
- Externally replaceable packing with split compression design

COMMON SERVICE CONDITIONS:

- Pressure Rating: 60" W.C.
- Maximum Operating Temperature: 300°F
- Materials: Dry Free Flowing

TYPICAL APPLICATIONS:

- Dust Collection
- Cyclone Separator

RELEVANT INDUSTRIES:

Wood	Grain
Food	Textile
Paper	Tobacco
Rubber	Paint



HD

S E R I E S

The Meyer Heavy-Duty Series airlock valves provide maximum versatility in the most severe applications. Each model offers an engineered cost effective solution to the customers needs. These units all have outboard bearing construction with an inboard packing design for maximum life and reduced maintenance. All rotor and shaft designs are oversized to eliminate shaft deflection and fatigue. The HD Series provides the right valve for any application.



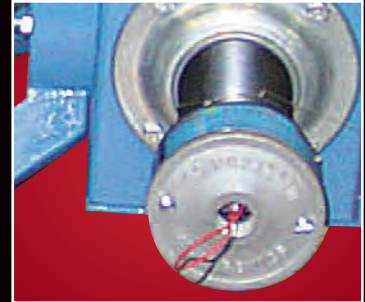
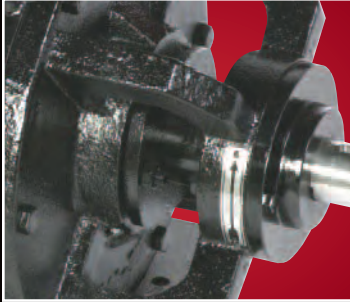

HDX | HDAR | HDXP

The HDX Heavy-Duty Drop-Thru Extra Tough, HDAR Heavy-Duty Abrasion Resistant and HDXP Heavy-Duty Explosion Proof rotary airlock valves are designed to withstand high temperatures and pressure differentials up to 15 psi. This legendary design sets the standard by which all others in the industry are measured. It offers the heaviest gauge rotor vane stock of any competing product, extra thick endplates, flanges and housing walls, along with outboard mounted oversized bearings that are prelubricated and permanently sealed to ensure low maintenance and prolonged life.

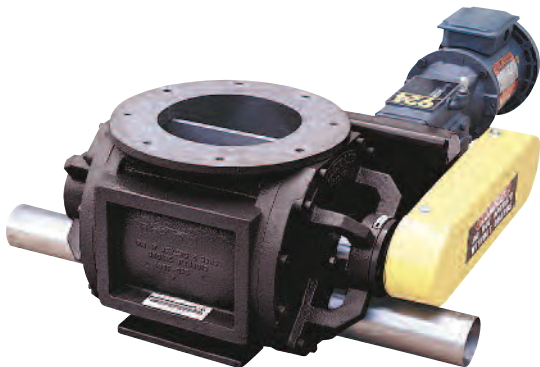

HDBT

The HDBT Heavy-Duty Blow-Thru model rotary airlock valves provide a specialized solution to your unique needs. These models provide a cost effective valve for your pneumatic conveying, or low profile application requirements.



HDPV | HDSE

The HDPV Heavy-Duty Pellet Valve and the HDSE Heavy-Duty Side-Entry model rotary airlock valve lines are specially designed with offset inlet and discharge openings to reduce product shearing while maintaining an efficient product flow in conveying or metering applications.



SQUARE	CFR	ROUND	CFR
6X6	0.07	6X6	0.07
8X8	0.18	8X8	0.18
10X10	0.36	10X10	0.36
12X12	0.64	12X12	0.64
12X21	1.08	-	-
14X14	1.12	14X14	1.12
16X16	1.62	16X16	1.62
18X18	2.29	-	-
22X22	4.34	-	-
26X26	7.3	-	-
30X30	11.3	-	-
36X36	20	-	-

The HDX Heavy-Duty Extra-Tough Drop-Thru rotary airlock valves are designed to withstand high temperatures and pressure differentials up to 22 psi. This legendary design sets the standard by which all others in the industry are measured. It offers the heaviest gauge rotor vane stock of any competing product, extra thick endplates, flanges and housing walls, along with outboard mounted oversized bearings that are pre-lubricated and permanently sealed to ensure low maintenance and prolonged life.

The HDX is available with 6-vane or 8-vane rotor design. Square or round flange housing with cast iron, 304/316 stainless steel or Ni-hard construction.

UNMATCHED COMPETITIVE ADVANTAGES:

- Available in twelve sizes from 6x6 through 36x36
- Round or square flange assures system compatibility
- Larger diameter shafts for less deflection and optimum torque delivery
- Full flow throat design permits maximum flow to rotor pocket
- Permanently sealed bearings ensure protection from contamination
- Special rotor designs including coatings, polishing, shallow pockets and closed end to specifically match your application
- Housing coating options include hard chrome, nickel, teflon, tungsten carbide, chrome carbide and plasma
- Cast iron and stainless steel housings are standard providing maximum structural stability with optional cast materials available including; inconel, hastelloy, cast steel or aluminum

COMMON SERVICE CONDITIONS:

- Pressure Rating: 22 PSI
- Maximum Operating Temperature: 1,000°F
- Materials: Dry Free-Flowing Including: Corrosive, Hygroscopic, Abrasive

TYPICAL APPLICATIONS:

- Pneumatic Conveying Blending
- Dust Collection Drying
- Pollution Control Weighing
- Mixing Feeding

RELEVANT INDUSTRIES:

- Asphalt Cement
- Food Power
- Baking Mining
- Chemical Paint
- Plastics Petrochem



HDAR Heavy-Duty Abrasion-Resistant



CERAMIC	CFR	DURAKAST	CFR
8X8	0.145	8X8	0.145
10X10	0.296	10X10	0.296
12X12	0.514	12X12	0.514
14X14	0.946	14X14	0.946
16X16	1.39	16X16	1.39
-	-	18X18	2.06

The HDAR Heavy-Duty Abrasion Resistant Drop-Thru rotary airlock valves are designed for severe applications where highly abrasive conditions exist. Offered in a choice of ceramic lined or DuraKast™, both can significantly improve the wear factor on the valve and reduce the pre-mature equipment failure often associated with such applications.

The ceramic version starts with any of our Heavy-Duty rotary airlock valves. We bond ceramic tiles to the inside of the cast iron housing and on the rotor tips. The DuraKast units are completely cast out of a hard chrome material suitable for applications with higher pressure differentials. The DuraKast units also have Stellite™ on the rotor tips for extended abrasion resistance. Both styles offer extended life over that of a standard cast iron rotary valve by as much as 6 times.

UNMATCHED COMPETITIVE ADVANTAGES:

CERAMIC

Precision-Cut ceramic tiles bonded in place minimizing gap exposure

Closed-End rotor designs with ceramic tiled end disc perimeter and tungsten carbide tips for prolonged wear resistance

HVOF spray on packing area for extended shaft life

Ceramic can be re-ground for additional life

DURAKAST

650 Bhn high chrome wear resistant casting for maximum life

Oversized square flange housing thickness designed to be re-ground for many years of service (round not available)

Pre-Cast flange holes allow for easy field installation on new or replacement units

Closed-End rotor with welded hard faced stellite tips for maximum wear resistance

End plates are hard chrome lined with optional purging feature

Higher pressure differentials for highly abrasive applications

COMMON SERVICE CONDITIONS:

Pressure Rating: 22 PSI

Maximum Operating Temperature:
250°F (Ceramic), 750°F (DuraKast)

Materials: Dry Free-Flowing Extremely Abrasive Particles

TYPICAL APPLICATIONS:

Pneumatic Conveying Blending

Dust Collection Drying

Grinding Weighing

Mixing Feeding

RELEVANT INDUSTRIES:

Mining – Sand, Alumina, Copper

Power - Fly Ash, Coal

Cement – Kiln Dust, Raw and Finished

Asphalt – Limestone, Granite

Steel – Oxides, Grinding Dust, Sinter



The Meyer HDXP Heavy-Duty, NFPA design valves are custom applied units to your specific application. Meyer engineers review the application and evaluate the design based on K_{st} values for the material, temperature, pressure and ambient conditions. Units can be built in cast iron, stainless and cast steel to match the specific NFPA requirements. Special XP switches, controls and motors are also added as needed to match the installation environment. Each valve is uniquely built and documented. The Meyer HDXP is ideally suited for all your NFPA installations.

UNMATCHED COMPETITIVE ADVANTAGES:

- Available in nine sizes from 6x6 through 22x22
- Round or square flange assures system compatibility
- Larger diameter shafts for less deflection and optimum torque delivery
- Full flow throat design permits maximum flow to rotor pocket
- Permanently sealed bearings ensure protection from contamination
- Housing coating options include hard chrome, nickel, teflon, tungsten carbide, chrome carbide and plasma
- Cast iron and stainless steel housings are standard providing maximum structural stability with optional cast materials available including; inconel, hastelloy or cast steel

SQUARE	CFR	ROUND	CFR
6X6	0.07	6X6	0.07
8X8	0.18	8X8	0.18
10X10	0.36	10X10	0.36
12X12	0.64	12X12	0.64
12X21	1.08	–	–
14X14	1.12	14X14	1.12
16X16	1.62	16X16	1.62
18X18	2.29	–	–
22X22	4.34	–	–

COMMON SERVICE CONDITIONS:

- Pressure Rating: 15 PSI
- Maximum Operating Temperature: 500°F
- Materials: Dry Free-Flowing Semi-Abrasive

TYPICAL APPLICATIONS:

- Pneumatic Conveying Pollution Control
- Blending Weighing
- Dust Collection Mixing
- Drying Feeding

RELEVANT INDUSTRIES:

- Coal
- Grain
- Food
- Textile
- Paper
- Power
- Petrochemical
- Mining

HDBT Heavy-Duty Blow-Thru

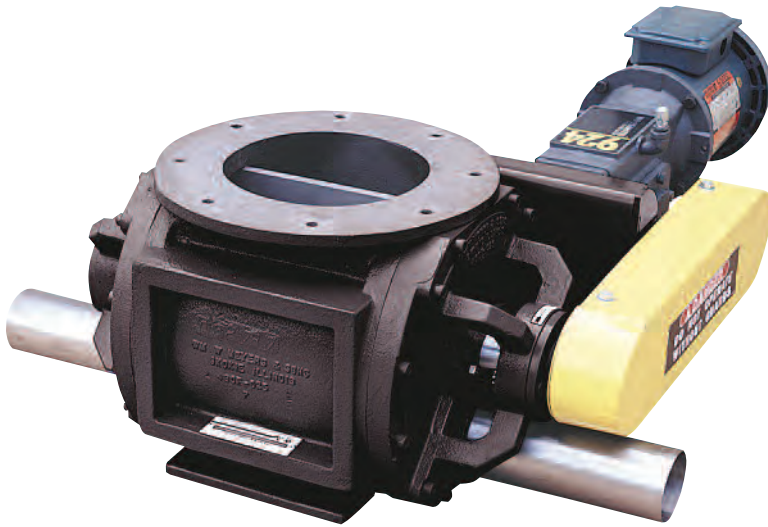

SQUARE	CFR	ROUND	CFR
11X10	0.47	11X10	0.47
-	-	13X12	0.8

The HDBT Heavy-Duty Blow-Thru rotary airlock valves are ideal for the Pneumatic Conveying of free-flowing material in food, grain, chemical, milling, baking, plastics and pharmaceutical applications. These units are uniquely designed to handle non-abrasive powders and where the product requires an assist in clearing the rotor vane pockets. The HDBT design is especially suited for low headroom installations and retro-fit applications.

UNMATCHED COMPETITIVE ADVANTAGES:

- Round or square flange assures system compatibility
- Rugged cast iron or stainless steel construction provides maximum structural stability
- Outboard sealed bearings never need lubrication
- 8-Vane open end beveled rotor standard
- Full taper inlet throat opening for maximum material flow to rotor pockets
- Integral mounting feet for easy installation

COMMON SERVICE CONDITIONS:

- Pressure Rating: 20 PSI
- Maximum Operating Temperature: 400°F
- Materials: Dry Fine Free-Flowing Non-Abrasive

TYPICAL APPLICATIONS:

- Pneumatic Conveying

RELEVANT INDUSTRIES:

- Grain
- Pharmaceutical
- Food
- Chemical
- Plastics
- Paint
- Baking
- Milling

HDPV Heavy-Duty Pellet Valve



ROUND CFR

12X12	0.61
-------	------

14X14	1.08
-------	------

16X16	1.55
-------	------

The HDPV Heavy-Duty Pellet rotary airlock valves are specially designed with offset inlet and discharge openings to reduce product shearing while permitting an even flow of pellets and chip materials into each rotor pocket. The design uses a slide gate to control the flow of pellets through the side inlet and into the rotor.

The HDPV eliminates serious jamming problems experienced with standard rotary airlocks by having the material enter the pocket from the side through a "V" type inlet and exiting through the bottom. This design is especially beneficial in handling pellets, chips, flakes and cubes resulting in reduced pocket degradation.

UNMATCHED COMPETITIVE ADVANTAGES:

Offset side inlet and discharge provides optimal material product flow

Round flange

Optional adjustable slide gate for optimal material feed rate control

"V" Type inlet throat minimizes product shearing and degradation

Housing vent connection improves valve efficiency

Rugged corrosion resistant cast stainless steel construction provides maximum structural stability

Outboard sealed bearings never need lubrication

8-Vane open end rotor standard for optimal air seal and product feed

COMMON SERVICE CONDITIONS:

Pressure Rating: 15 PSI

Maximum Operating Temperature: 750°F

Materials: Pellets, Chips, Flakes, Cubes

TYPICAL APPLICATIONS:

Railcar Unloading

Pneumatic Conveying

Vacuum Loaders

RELEVANT INDUSTRIES:

Plastics

Wood

Food

Pharmaceutical

Rubber

Chemical





SIZE	CFR
6X6	0.07
8X8	0.18
10X10	0.36
12X12	0.64
14X14	1.12
16X16	1.62
18X18	2.29
22X22	4.34

The HDSE Heavy-Duty Side-Entry Drop-Thru rotary airlock valves are designed for applications involving relatively large particles that cannot be reduced by the shearing action between the rotor blades and the housing at the inlet. They are also suitable for applications where small fines produced by the shearing action could cause damage to the system or create hazards. The built-in "V" shaped product inlet reduces the shearing to a single point virtually eliminating product degradation.

UNMATCHED COMPETITIVE ADVANTAGES:

- Offset V-type inlet design to eliminate shearing
- Cast iron or stainless steel construction for maximum stability
- Permanently sealed outboard bearings for reduced maintenance
- Oversize rotor and shafts for severe service duty
- Special rotor designs including coatings, polishing, shallow pockets and closed end to specifically match your application
- Housing coating options include hard chrome, nickel, teflon, tungsten carbide, chrome carbide and plasma

COMMON SERVICE CONDITIONS:

- Pressure Rating: 15 PSI
- Maximum Operating Temperature: 750°F
- Materials: Pellets, Chips, Flakes, Cubes

TYPICAL APPLICATIONS:

- Railcar Unloading
- Pneumatic Conveying
- Vacuum Loaders

RELEVANT INDUSTRIES:

- Plastics
- Mining
- Food
- Pharmaceutical
- Rubber
- Chemical



SV
SERIES

The Meyer Sanitary Valve Series is designed for fast disassembly, cleaning and re-assembly of the material contact surfaces. The Kwik-Klean® and Klean-In-Place II® models are specifically designed to be cleaned without tools and removal from service. Valves are available in standard cast iron, stainless and sanitary designs.



KK

The Kwik-Klean® rotary airlock valves are designed for fast and simple disassembly and re-assembly, allowing for quick inspection, clean-up and maintenance without the use of tools or removal of the valve from service. The valves use hand-tightened fasteners to secure the headplate to the housing. With the headplate and rotor conveniently removed, the entire housing interior is accessible. Re-assembly takes just minutes and internal clearances are automatically re-established every time.

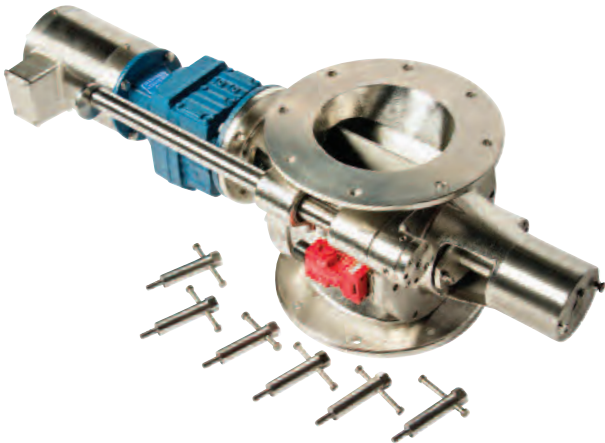

KIP II

The KLEAN-IN-PLACE II® rotary airlock valve is specially designed for applications where frequent cleaning, sanitizing or inspection of the bulk handling system is required and minimum downtime is critical. The KLEAN-IN-PLACE II® has uniquely designed features making it compliant for FDA, USDA, 3A dairy and NFPA standards with materials needed for food, dairy, chemical, and pharmaceutical applications. Our design incorporates a perfectly balanced 2-RAIL construction allowing the operator easy access to either clean the rotor, leaving it attached with the headplate or separating the rotor to completely remove for optimal cleaning.



SQUARE	CFR	ROUND	CFR
6X6	0.075	6X6	0.075
8X8	0.186	8X8	0.186
10X10	0.386	10X10	0.386
12X12	0.65	12X12	0.65

The Kwik-Klean® rotary airlock valves are designed for fast and simple disassembly and re-assembly, allowing for quick inspection, clean-up and maintenance without the use of tools or removal of the valve from service. The valves use hand-tightened fasteners to secure the headplate to the housing. With the headplate and rotor conveniently removed, the entire housing interior is accessible. Re-assembly takes just minutes and internal clearances are automatically re-established every time.

The valves are available in different design levels incorporating cast iron, stainless steel or polished sanitary construction.

UNMATCHED COMPETITIVE ADVANTAGES:

- Available in four sizes from 6x6 through 12x12
- Round or square flange assures system compatibility
- Cast iron, 304 SS or 316 SS housings are standard providing maximum structural stability
- Direct drive splined coupling for ease of assembly
- Available with packing and U-cup teflon seals
- Tool-Free hand fasteners for rotor removal and regular inspections
- Sanitary and electro polishing optional for dairy and pharmaceutical requirements
- Permanently sealed bearings ensure protection from contamination
- Special rotor designs including coatings, polishing and shallow pocket to specifically match your application
- Housing coating options include nickel and teflon
- Four levels of construction

COMMON SERVICE CONDITIONS:

- Pressure Rating: 15 PSI
- Maximum Operating Temperature: 400°F
- Materials: Dry Free-Flowing Food Grade or Contamination Sensitive Powders

TYPICAL APPLICATIONS:

- Pneumatic Conveying
- Blending
- Dust Collection
- Drying
- Weighing
- Mixing
- Feeding
- Packaging or Bagging

RELEVANT INDUSTRIES:

- Baking
- Dairy
- Pharmaceutical
- Food
- Powder Coating
- Spices
- Meat Processing
- Chemical



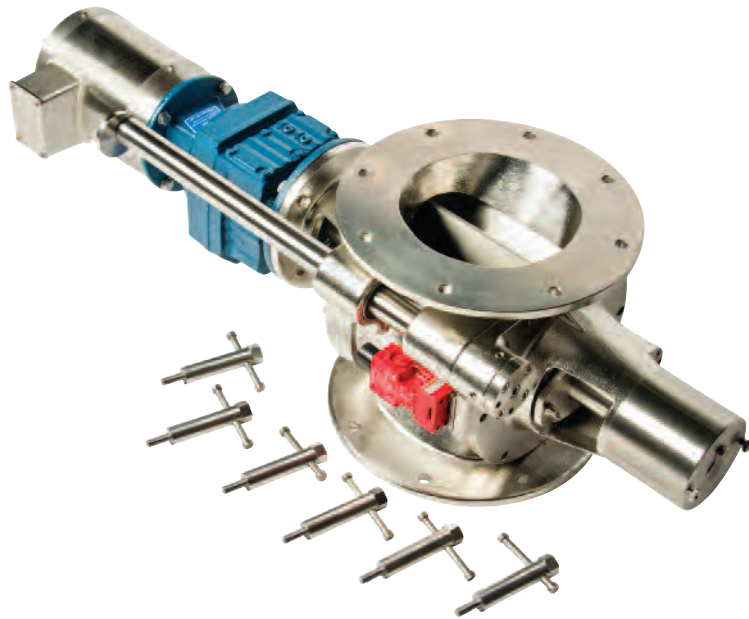

ROUND	CFR
6X6	0.095
8X8	0.23
10X10	0.48
12X12	0.90
14X14	1.54

The KLEAN-IN-PLACE II® rotary airlock valve is specially designed for applications where frequent cleaning, sanitizing or inspection of the bulk handling system is required and minimum downtime is critical.

The KLEAN-IN-PLACE II® has uniquely designed features making it compliant for FDA, USDA, 3A dairy and NFPA standards with materials needed for food, dairy, chemical, and pharmaceutical applications. Our design incorporates a perfectly balanced 2-RAIL construction allowing the operator easy access to either clean the rotor, leaving it attached with the headplate or separating the rotor to completely remove for optimal cleaning.

UNMATCHED COMPETITIVE ADVANTAGES:

- Available in five sizes from 6x6 through 14x14
- Round flange assures system compatibility
- 316 SS housings are standard providing maximum structural stability
- Self Aligning Drive, without the use of special tools
- Available with packing and multiple seal designs
- Tool-Free hand fasteners for rotor removal and regular inspections
- Safety switch signaling when unit is ready to run
- Permanently sealed bearings ensure protection from contamination

COMMON SERVICE CONDITIONS:

- Pressure Rating: 15 PSI
- Maximum Operating Temperature: 400°F
- Materials: Dry Free-Flowing Food Grade or Contamination Sensitive Powders

TYPICAL APPLICATIONS:

- Pneumatic Conveying
- Blending
- Dust Collection
- Drying
- Weighing
- Mixing
- Feeding
- Packaging or Bagging

RELEVANT INDUSTRIES:

- Baking
- Dairy
- Pharmaceutical
- Food
- Powder Coating
- Spices
- Meat Processing
- Chemical

A large industrial airlock valve in a factory setting. The valve is a large, cylindrical metal component with a complex internal structure, including a central shaft and various seals and bearings. It is mounted on a large, cylindrical metal tank. The background shows other industrial equipment, including pipes, ladders, and a tall, vertical stack of metal pipes. The sky is blue with some clouds.

CV

S E R I E S

The Meyer Custom Valve Series airlocks are highly specialized. These units are designed to handle oversized large material, high pressures or extreme temperatures. These products all provide an engineered solution to your most demanding system requirements.

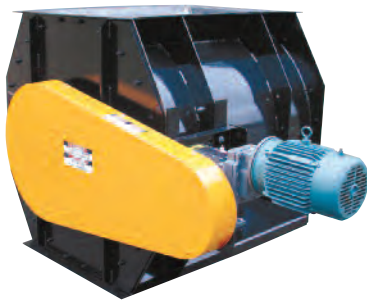
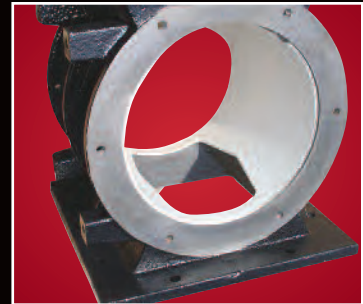
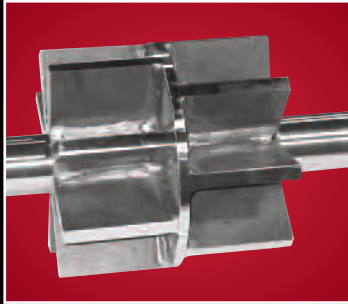

FV

The Meyer FV Fabricated rotary airlock valves are designed for use in low pressure dust collection, cyclone and pneumatic conveying applications. Their unique design allows oversized material to pass without binding issues experienced with other type of valves. These units provide the most economical solution in handling extremely large material rates.



HP

The HP High-Pressure rotary airlock valves are designed for high pressure conveying systems up to 50 PSI. These units feature oversized flanges and housings with reinforced rib design for maximum structural strength. The rotor design incorporates an oversized shaft and closed end rotor design to maintain a positive air seal. These valves are the perfect solution to convey non-abrasive products in medium dense phase conveying systems.



CD

Meyer CD Custom Design rotary airlock valves incorporate any of our standard product offerings but have significant modifications to specialize the valve to your specific application. The modifications can be as simple as special paint to requirements for highly engineered casting materials, drives, transitions or coatings. Meyer engineers can solve your most severe wear, corrosion, material or conveying valve application needs.



SIZE	CFR
24X24	5.9
30X30	11.8
36X36	21
48X48	49.5

Meyer FV Fabricated rotary airlock valves are especially suited to handle large volumes of light to medium density products including large irregular material typically found in dust collection and low pressure pneumatic systems. These valves are available in carbon steel, stainless steel or abrasion resistant steel as an economical solution. The precision cut and welded valves feature flange type bearings, ribbed housing and headplates, with replaceable neoprene, viton or urethane sealstrips.

UNMATCHED COMPETITIVE ADVANTAGES:

- Four standard sizes with custom sizes available to meet your system requirements
- Oversized flange assures valve stability
- Fabricated carbon steel, stainless steel or abrasion resistant steel construction to meet your specific application
- Flange type bearings for extended valve life
- Replaceable neoprene, viton or urethane sealstrips for maximum sealing
- Optional seal or packing available for special applications
- Reinforced rotor with inter blade gussets insuring vane rigidity

COMMON SERVICE CONDITIONS:

- Pressure Rating: 2 PSI
- Maximum Operating Temperature: 150°F
- Materials: Light to Medium Density Products: Chips, Flakes, Strips, Lumps

TYPICAL APPLICATIONS:

- Pneumatic Conveying
- Dust Collection
- Cyclone

RELEVANT INDUSTRIES:

- Wood
- Paper
- Insulation
- Textile
- Recycle
- Plastic
- Grain



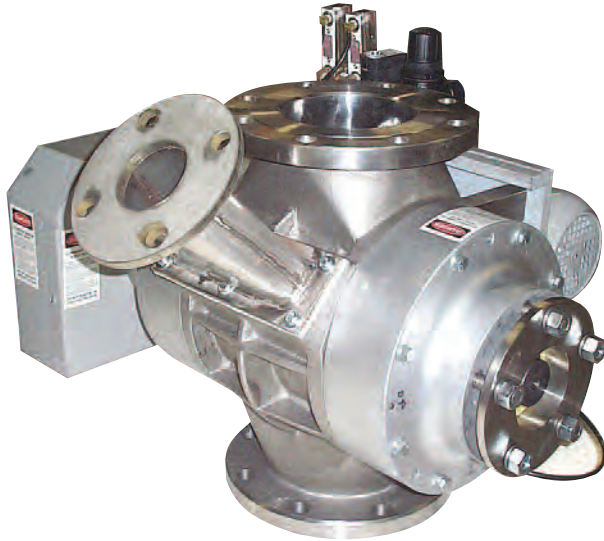

SIZE	CFR
6"	0.18
8"	0.38
10"	0.75
14"	1.5
16"	3
20"	6

The HP High-Pressure rotary airlock valves are specifically designed for high-pressure plastic conveying systems where non-abrasive continuous material feed is required. The valves feature thicker ribbed housings and flanges specially suited for 50 PSI systems. Headplates feature a proprietary shaft bearing and rotor seal design minimizing air leakage. High pressure rotor design, including oversized shaft and blade materials, keep shaft deflection to a minimum.

UNMATCHED COMPETITIVE ADVANTAGES:

- Available in six sizes 6" through 20"
- Standard venting ensuring proper material flow
- Housing options include hard coat aluminum and stainless steel
- Stainless steel rotor is standard
- Proprietary shaft bearing and rotor seal design minimizes air leakage

COMMON SERVICE CONDITIONS:

- Pressure Rating: 50 PSI
- Maximum Operating Temperature: 200°F
- Materials: Non-Abrasive Powders and Granular

TYPICAL APPLICATIONS:

- Pneumatic Conveying

RELEVANT INDUSTRIES:

- Plastics
- Petrochemical
- Pharmaceutical
- Chemical

The CD Custom Design Series rotary airlock valves are a culmination of three generations of Meyer application expertise. These valves are designed to handle extreme operating conditions, unique customer needs or unusual installation requirements.

Meyer sales engineers work directly with the customer to tailor a custom solution to their problem.

UNIQUE FEATURES AVAILABLE:

High Temperature Design

Special Housings

Steam Jacketing

Special Paint

Special Coatings

Custom Transitions

Special Drives

Custom Guards

Special Rotors

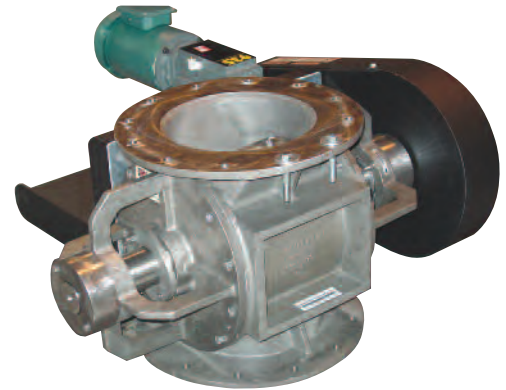

High Temperature

Bearing

Packing

Heat Shields

Castings for 1500°F Operation



Steam jacketed airlocks for sensitive conveying and material applications.

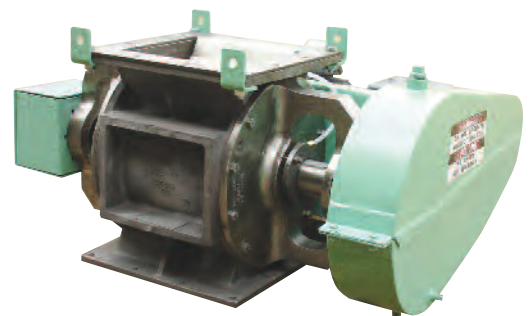

Special oil tight guards, taconite seals and flange options to meet your custom applications.

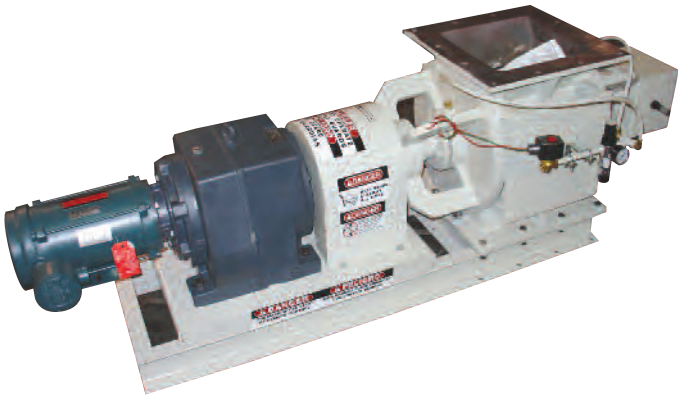

Customer specific motors and drives to meet the most stringent demands.

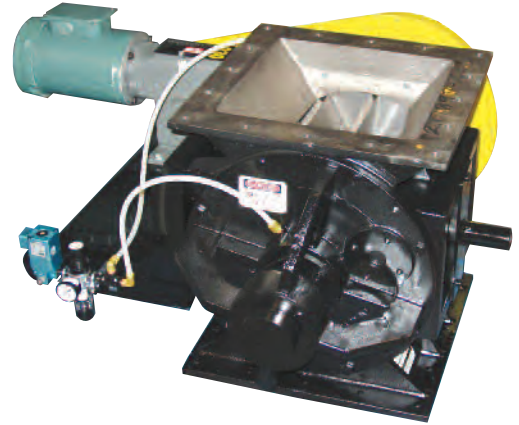

Special valve controls and switches are pre-assembled to ease field installation.

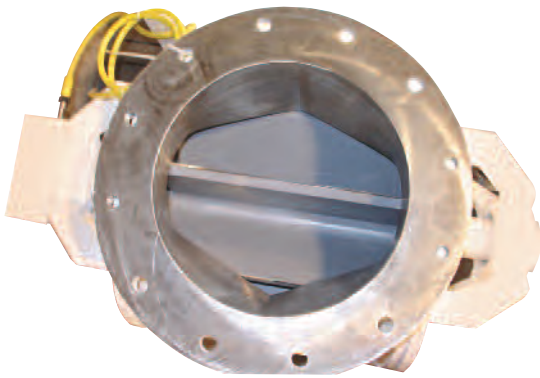

Wide variety of special coatings, polishing and rotor treatments to enhance valve operation.



Special design rotors with shallow pockets, staggered vanes, shaft extensions and polishing are available to match the valve to the material.



Meyer matches any customer paint or specification for maximum durability in severe conditions.

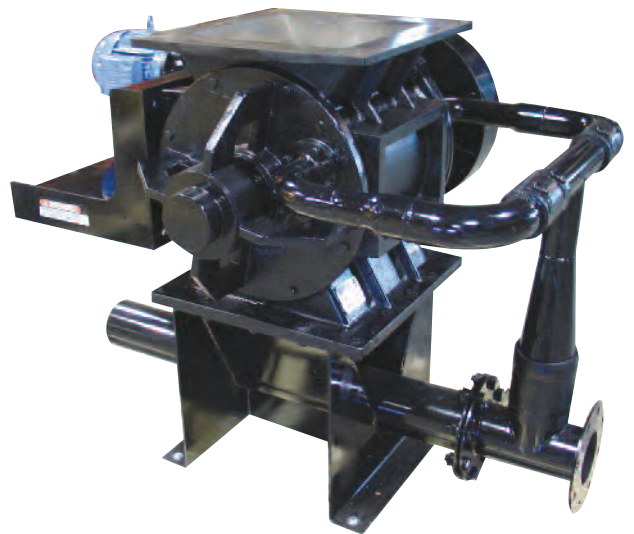

Air swept headplate purge design to eliminate material build-up and improve valve life.

System Components

In addition to Rotary Airlock Valves, Meyer designs, engineers and manufactures a wide variety of other products designed specifically for bulk processing applications. Like our rotary valves, these products are designed and built to withstand the rigors of demanding applications. The next time you are in the market to repair, replace or upgrade your process system components, give us a call. We manufacture all the key components for pneumatic conveying, process metering and dust control.



Double-Flapgate
Airlock Valves



Line Diverter Valves



Swing Gates

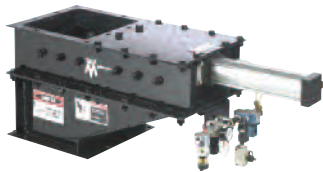

Slide Gates



Double Clam
Shell Gates



Rotary Plug Valves



Knife Gates



Gravity Flow Diverter Valves



Screwveyor Pumps



Blower Packages

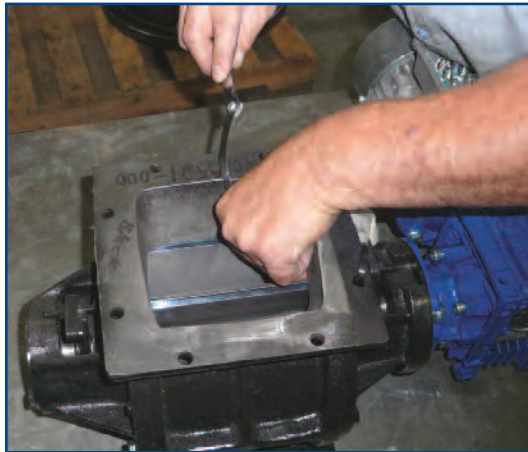

Since 1946, Wm W. Meyer & Sons has been delivering quick, conscientious service and superior craftsmanship on replacement parts to customers throughout the country. We understand the costs of downtime, and make it our highest priority to help you keep your plant running troublefree. Our on-site preventative maintenance programs, responsive repair services and quick-ship replacement parts capabilities help us deliver the extra value customers need in today's competitive marketplace.

In addition to maintaining and repairing our own Rotary Airlock Valves, we also provide expert repair services on other manufacturers' products.

WE OFFER REPAIR SERVICES ON THESE AND OTHER SYSTEM COMPONENTS:

Rotary Airlocks

Double-Flapgates

Diverters

Slide Gates

Screw Pumps

Valves

Many times, repairs can be done right on the spot to minimize production disruption and speed start-up. However, when it is impractical to repair a unit on site, it will be shipped to our repair facility for immediate attention. It will be torn down, carefully inspected and restored to like-new condition, including a return to the original tolerances.

COMPREHENSIVE EVALUATION ON EVERY UNIT:

Complete disassembly

Inspection of each component

Comparison to original manufacturers' specs and tolerances

Repair or replacement of worn or damaged component parts

Genuine OEM Parts

Re-assembly

Final Testing

Service Warranty

If your equipment is beyond repair or it is not economical to repair it, Meyer will give you the option of choosing between a new or re-manufactured piece of equipment from available stock.



Wm. W. Meyer & Sons, Inc.
1700 Franklin Blvd.
Libertyville, IL 60048

847-918-0111
800-963-4458

www.wmwmeyer.com